

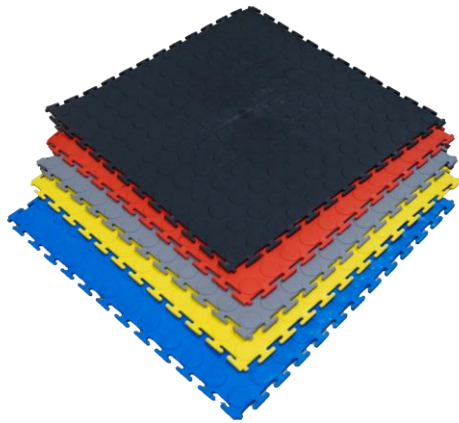

PROAUTO RUBBER AUSTRALIA



Suppliers of
Interlocking Floors

PRODUCT LINE

Manufacturers and suppliers of world class
rubber and PVC extrusions and mouldings



Proudly Australian owned and operated



PROAUTO RUBBER AUSTRALIA

WE ARE PROAUTO RUBBER

Proauto Rubber Australia is an independent locally owned wholesaler and retailer of automotive, commercial and industrial rubber products based in Albury NSW.

PAR was originally founded in South Africa where we have a combined 22 years of experience in the rubber industry including manufacturing, retail, wholesale and distribution. Most products are manufactured by our own plant in Boxburg, South Africa. Other products are sourced locally, within Australia and from partner manufacturing firms globally.

Proauto Rubber specialises in universal automotive and industrial rubber extrusions and sheeting. Our product applications extend to an ever-increasing list of industries, including manufacturing firms, automotive mechanics & panel shops, automotive and building window glazing, construction & trades people, general & civil engineering, mining sectors, agriculture & abattoirs as well as professional offices & local retailers.

Our team is dedicated to providing quality rubber products at a fraction of the expected cost. Our focus is providing reliable service and effective, thorough communication to all of our valued clients. Whether you buy a metre or a container shipment from us, we will give you the same level of service guaranteed.

Our catalogue is not all inclusive of PAR's manufacturing capability. We design, manufacture and supply a range of custom extrusions to our valued customers. If you cannot find the product for your application, please give the team a call and we will provide or source a custom solution for you.

Contact the team on:

(02) 6025 0194

sales@proautorubber.com.au

919 Metry St North Albury NSW 2640

1.

www.proautorubber.com.au



Rubber – What – Where – How - Why

Natural Rubber

Produced from a tropical tree, for over one hundred years rubber was based on natural rubber.

Ethylene Propylene Diene Monomer (EPDM)

Used for glazing & refrigeration Extrusions
Good heat resistance
Excellent weather resistance
Good low temperature resistance

Nitrile (NBR)

Used in 'O' rings
Good mechanical properties
Excellent resistance to oils & fuels
Good alkali and acid resistance

Nitrile Food Quality (NFO)

Food gaskets, buffers & liners
Good oil & heat resistance
Non-toxic
Non-swelling

Synthetic Rubber

Made in factories from crude oil since the 1930s. Rubber compound will have ± 18 ingredients

Silicone (si)

Extreme temperatures Like oven door seals Heat resistance up to 250°C Excellent weather resistance Moderate fuel resistance

Neoprene (cr)

Used in oil and fuel gaskets Good mechanical properties Excellent weather resistance
Flame resistant

Polyvinyl chloride (pvc)

Used to extrude pinch Weld & building profiles
Good for UV resistance
Non-marking

Thermoplastic

Polymers that can be melted and recast almost indefinitely. Molten when heated and harden when cooled. Represent over 75% of the worlds consumer plastics. Used to manufacture moulded vehicle floor mats.

Rubber is used in a wide range of products!

Tyres - Tubes - Engine Mountings - Screen Door Universal Extrusions - Building Profiles-Sheeting - Flooring - Hoses - Footwear - Belting - Tubing - Gaskets - Cables – Grommets-Bushes - Rollers - Handle Grips - Tools - Ute Mats - Trailer Mats - Mudflaps - Diving Suits Elastic - Balloons - Tank Linings - Pipelines - Gloves - Fan Belts - Oil Seals - Dummies Bottle Teats - Squash Balls - Tennis Balls - Golf Balls - Rugby Balls - And Many More ...



CONTENTS

<u>We are PAR</u>	<u>1</u>
<u>Rubber – What – Where – How – Why</u>	<u>2</u>
<u>Contents Page</u>	<u>3</u>
<u>4x4 Mats</u>	<u>4</u>
<u>Sheet Rubber</u>	<u>5</u>
<u>Insertion Rubber</u>	<u>6</u>
<u>Horse, Equine & Agriculture Rubber</u>	<u>7</u>
<u>Rubber Mats</u>	<u>8</u>
<u>Ute Matting, Water Jet Cutting</u>	<u>9</u>
<u>Entrance Mats</u>	<u>10</u>
<u>Rubber Flooring Solutions</u>	<u>11</u>
<u>Automotive Clips, Anti-vibration Pads</u>	<u>12</u>
<u>Self Adhesive Foam Tape</u>	<u>13</u>
<u>Dock Fenders</u>	<u>15</u>
<u>Pinch Welds</u>	<u>16</u>
<u>Door Seals</u>	<u>17</u>
<u>Universal & Vehicle Specific Extrusions</u>	<u>18</u>
<u>Universal Sponge Extrusions</u>	<u>19</u>
<u>Universal Fender Welt, Wheel Arch Flares</u>	<u>20</u>
<u>Weather Strip, Automotive Glazing Rubber</u>	<u>21-22</u>
<u>Bailey Channel, Building Profiles</u>	<u>23</u>
<u>Self Adhesive Sponge Extrusions, P Section</u>	<u>24</u>
<u>U Channel, Capping Rubber, L Section</u>	<u>25</u>
<u>Bracket Straps, Tank Straps</u>	<u>26</u>
<u>EPDM Sponge Extrusions</u>	<u>27</u>
<u>Solid EPDM Blocks</u>	<u>28</u>
<u>Solid EPDM Rubber Strips</u>	<u>29</u>
<u>EPDM Sponge Cord</u>	<u>30</u>
<u>Gunwhale Rubber</u>	<u>31</u>
<u>Cable Protectors</u>	<u>32</u>
<u>Wiring Grommets</u>	<u>33</u>
<u>Blanking Grommets</u>	<u>34</u>
<u>Cyanoacrylate Adhesive Super Glue</u>	<u>35</u>
<u>Hoist Lift Blocks, Anti-Vibration Blocks</u>	<u>36</u>
<u>Mudflaps, Wheel Chocks</u>	<u>37</u>



**HEAVY DUTY 4x4
FITTED FLOORING**



AVAILABLE FOR:



TOYOTA HILUX +
FORTUNA



HOLDEN COLORADO +
COLORADO 7



FORD RANGER +
EVEREST



TOYOTA LANDCRUISER



TOYOTA LANDCRUISER
79 SERIES



MAZDA BT50



VOLKSWAGON AMAROK



ISUZU DMAX + MUX

& MORE



SHEET RUBBER

PAR manufactures and supplies SBR sheeting as standard in pattern, textured or smooth finishes.

Stud Coin Sheet

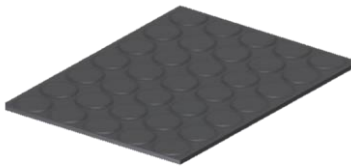

Wide Ribbed Sheet

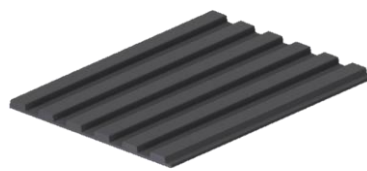

Checker Plate Sheet



Pyramid Sheet

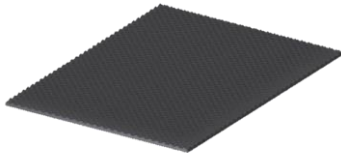

Diamond Sheet



Fine Ribbed Sheet

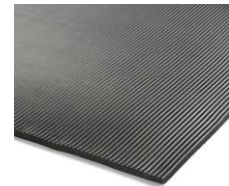

Super Grip Sheet

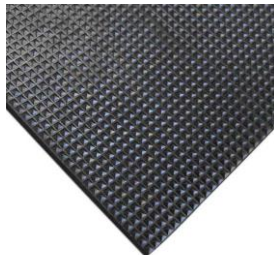

Available Thicknesses:

1.5mm, 1.6mm, 3mm, 4.5mm, 6mm.

Other sizes available on request.

Roll Widths Available:

1200mm, 1500mm, 1600mm.

Available in natural rubber, pure gum, styrene-butadiene (SBR) blend (as standard), nitrile (NBR) and ethylene propylene diene monomer (EPDM). We have a material and finish to suit most requirements, please enquire within.



STANDARD 10 METRE ROLL

applies on wholesale orders or available by the metre in store.



INSERTION RUBBER



Premium & Commercial Grade Insertion Rubber – Reinforced to improve tear strength with a woven cotton/fabric ply as standard. PAR manufactures and supplies styrene-butadiene (SBR Blend) as standard.

Available in natural rubber, styrene-butadiene (SBR) blend (as standard), nitrile (NBR) and ethylene propylene diene monomer (EPDM). We have a material and finish to suit most requirements, please enquire within.



Standard Thicknesses Available:

1.6mm, 3mm, 4.5mm & 6mm

Standard Roll Widths Available:

1200mm, 1500mm & 1600mm

STANDARD 10 METRE ROLL

applies on wholesale orders or available by the metre in store.



HORSE, EQUINE & AGRICULTURE RUBBER

Super heavy duty sheet rubber designed for the equine, horse racing and agriculture industry. Made with a higher density compound, a thicker sheet with more woven ply layers to ensure maximum tear and rip resistant.



Equine Matting

Standard 2 metre x 10 metre roll.

Textured finish on the underside for stability, with a honeycomb bubble pattern top side for grip on the animals shoes.

Can be supplied by the metre in store.

Super Heavy Duty Cow Mat

Standard size single unit 1220mm x 1880mm. Raised bubble on one side, cleated smooth finish on the other. Available in 12mm or 18mm thicknesses.

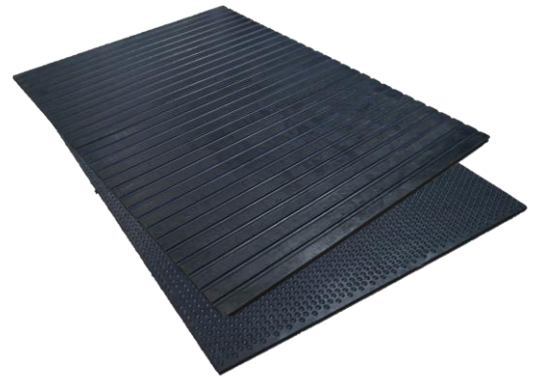

Stepped Loading Ramp Mat

Standard or custom sizing available.

Made from a high density compressed sheet with a textured finish. Steps are moulded into the sheet as part of the production process to ensure the animals shoes will not tear or strip away the step.

Excellent cushion and anti-vibration properties.

Stripped Insertion Rubber

Available in custom lengths and widths to suit round yard, trotting ring, stable or other agriculture related fencing. Can also be used as chassis rail strip, anti-vibration runners, some light duty conveyer systems, some sealing solutions, edging, vermin control, mud guards and stone protection under trailers, just to name a few applications. Some standard widths held as stock.

Minimum quantities apply.





RUBBER MATS

All PAR Rubber Mats are made from a NBR (Nitrile) Blend for resistance against petroleum based liquids or chemicals and add resilience in any workplace application.

ERGONOMIC ANTI-FATIGUE MAT

900mm x 600mm & 1200mm x 900mm

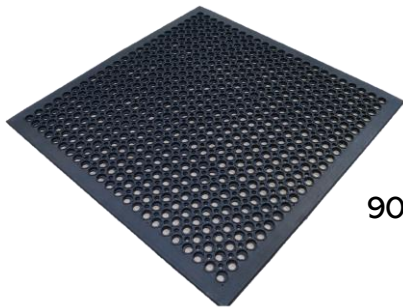

DRAINAGE/HOSPITALITY MAT

900mm x 900mm 12mm & 930mm x 1550mm 12mm

Rubber Anti-Fatigue Bubble Mat Roll

900mm x 9300mm Black 15mm

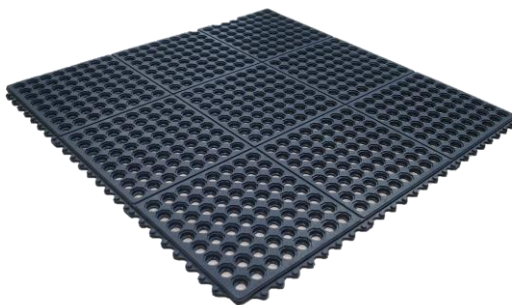

MODULAR MAT - OPEN HOLE BLACK

900mm x 900mm

Modular Anti-Fatigue Mats can be linked together in a continuous line or as a larger square mat.



UTE MATTING



Standard size available: 1830mm wide x 10m roll.
Premium Grade, made from an NBR blend giving some petroleum based fluid resistance. Cut to size for your ute in store upon request. Easily DIY trimmed for a custom fit in your tub around wheel arches.

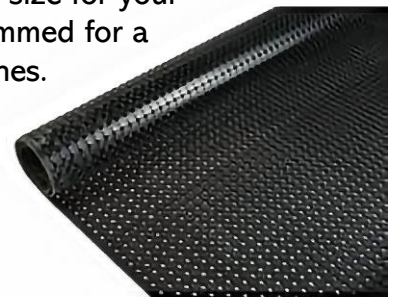

WATER JET CUTTING



PAR Australia in partnership with a local manufacturer, using water jet cutting technology can have rubber sheeting cut into any shape or size to suit your requirements.

Contact the team on:

(02) 6025 0194

sales@proautorubber.com.au

919 Metry St North Albury NSW 2640



ENTRANCE MATS

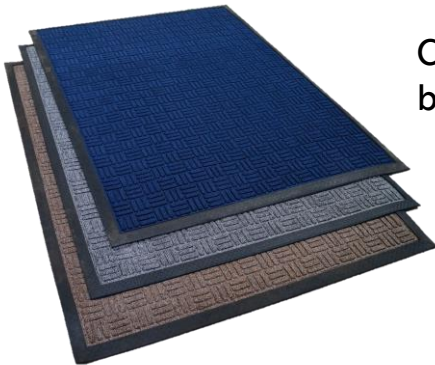

Coloured Entrance Mats are rubber backed for best surface grab and durability.

Coloured Entrance Mat 1200mm x 900mm x 8mm

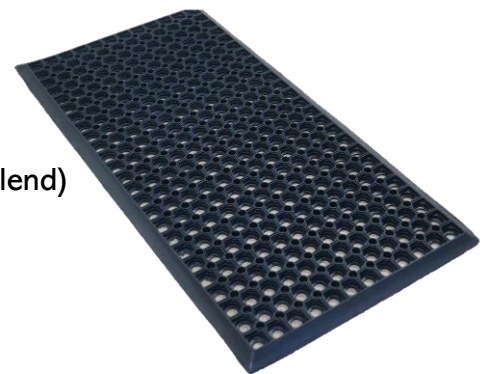

RINGMAT Sloped Edges (NBR Blend)
1000mm x 500mm x 18mm



Turtle Shell Design Black (NBR Blend)
1500mm x 900mm

Fingertip Design Entrance Mat (NBR Blend)
1200mm x 800mm & 1500mm x 900mm

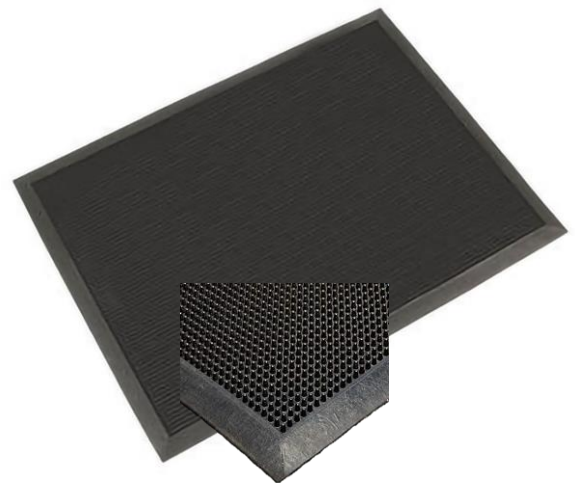

All PAR Rubber Mats are made from a NBR (Nitrile) Blend for resistance against petroleum based liquids or chemicals and add resilience in any workplace application.



RUBBER FLOORING SOLUTIONS

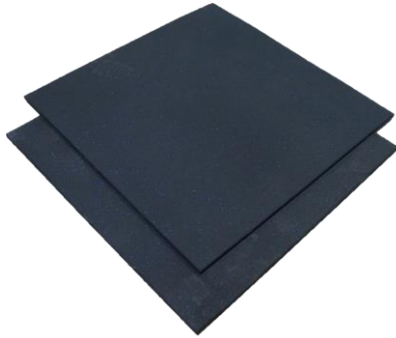

GYM TILES

Premium Grade Rubber Gym Tiles/Mats made from 100% recycled Rubber Tyres. Completely stripped of any wire content left over from the recycling process. Up to 10% EPDM Blue Fleck throughout.

A very high resin content making for a much more dense, heavier and durable surface that is even easier to mop in a commercial gym.

Crossfit? Powerlifting? Made 15mm thick as the minimum standard for most reputable barbell company warranties and terms. A perfect square metre in size making calculating your flooring requirements and fitment a breeze.



INTERLOCKING FLOORS

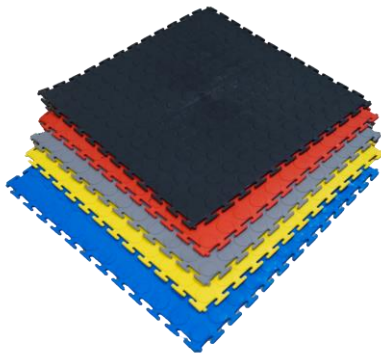

Multi-purpose PVC floor tiles used as a floor covering for any type of surface, these are ideal for protecting both floor and user. This industrial flooring option is available to protect workers, machines and equipment throughout the daily grind, adding a dependable layer that is easy to clean and won't weather. Moulded from heavy duty thermo-plastics to ensure continual use with minimal wear and tear. Ideally suited to the home garage, gym or shopfront, these interlocking PVC tiles are a long lasting and grip-heavy surface perfect for a range of applications.

Product size: 500mm x 500mm x 5mm (4 x tiles interlocked to form 1 square metre)

Colours Available: Black, Dark Grey, Light Grey, Blue, Red, White, Green, Yellow, Orange. **(Black colour range manufactured from recycled plastics)**

Interlocking PVC Tile Edging Available for the finished look.





AUTOMOTIVE CLIPS



PAR Australia supply a wide range of automotive clips, ranging in colour & size. Wholesale & Trade prices Available Bulk or Individual orders.

ANTI-VIBRATION PADS

WAFFLE PADS

457 X 457 X 8

SUPPLIED IN BOXES OF 20 PADS

An inexpensive material for effective control of machinery vibration, shock and acoustic noise.



ST AVIBE - 20 METRE COIL ST
AVIBE1000 - METRE STRIP

Supplied in 20 metre rolls or 1 metre lengths. An ideal product for use when a long line of vibration resistance is needed.



SELF ADHESIVE FOAM TAPE

Different materials for different applications available including PVC & Polyethylene, Neoprene & Nitrile blends. Closed & open cell, soft & hard varieties – Closed cell PE/EVA stocked as standard.

Just ask the PAR team for assistance in selecting the best solution for you.

Material – PE/EVA Application

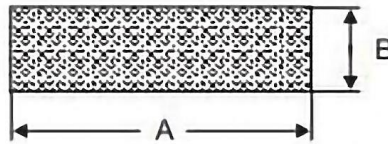

Product #	Material	A (mm)	B (mm)	Roll Length (M)
PX33-03-10	PE/EVA	3	10	10
PX33-03-15	PE/EVA	3	15	10
PX33-03-20	PE/EVA	3	20	10
PX33-03-25	PE/EVA	3	25	10
PX33-03-30	PE/EVA	3	30	10
PX33-03-40	PE/EVA	3	40	10
PX33-06-10	PE/EVA	6	10	10
PX33-06-15	PE/EVA	6	15	10
PX33-06-20	PE/EVA	6	20	10
PX33-06-25	PE/EVA	6	25	10
PX33-06-30	PE/EVA	6	30	10
PX33-06-40	PE/EVA	6	40	10
PX33-08-10	PE/EVA	8	10	10
PX33-08-15	PE/EVA	8	15	10
PX33-08-20	PE/EVA	8	20	10
PX33-08-25	PE/EVA	8	25	10
PX33-08-30	PE/EVA	8	30	10
PX33-08-40	PE/EVA	8	40	10
PX33-010-10	PE/EVA	10	10	10
PX33-010-15	PE/EVA	10	15	10
PX33-010-20	PE/EVA	10	20	10
PX33-010-25	PE/EVA	10	25	10
PX33-010-30	PE/EVA	10	30	10
PX33-010-40	PE/EVA	10	40	10

See following page for our Nitrile/Neoprene blend tapes.

Other Materials Available. Enquire Within.



**NITRILE/NEOPRENE
SELF ADHESIVE FOAM TAPES**

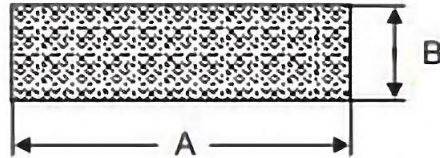

Material - Neoprene/ Nitrile Blend

Product #	Material	A (mm)	B (mm)	Roll Length (M)
FT FS47312	NBR/CR	3	12	25
FT FS47612	NBR/CR	6	12	12.5
FT FS47912	NBR/CR	9	12	8
FT FS471212	NBR/CR	12	12	6
FT FS47318	NBR/CR	3	18	25
FT FS47618	NBR/CR	6	18	12.5
FT FS47918	NBR/CR	9	18	8
FT FS471218	NBR/CR	12	18	6
FT FS47324	NBR/CR	3	24	25
FT FS47624	NBR/CR	6	24	12.5
FT FS47924	NBR/CR	9	24	8
FT FS471224	NBR/CR	12	24	6
FT FS47348	NBR/CR	3	48	25
FT FS47648	NBR/CR	6	48	12.5
FT FS47948	NBR/CR	9	48	8
FT FS471248	NBR/CR	12	48	6

* Some sizes are stock items, others available on request. Please ask the PAR team



DOCKING RUBBER



MOL20 – MOULDED DOCKING BAY RUBBER



DOCK450 – CUT TO 450mm & Drilled



DE7711-450NON – CUT TO 450mm

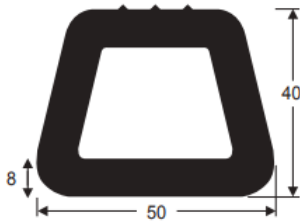

DR440

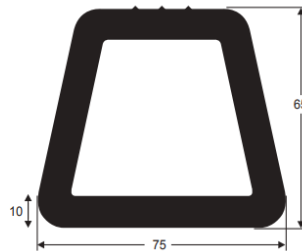

DR441

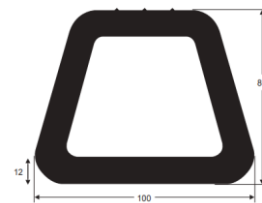

DR442

^^STANDARD 3 METRE LENGTHS^^
MANUFACTURED TO ORDER

PAR manufacture premium, super heavy duty dock fenders that last longer and perfect for protecting your boat, trailer or truck.

Sizes:
Small, Large or Custom lengths. Enquire within.



Contact the team on:

(02) 6025 0194

sales@proautorubber.com.au

919 Metry St North Albury NSW 2640



PINCH WELD

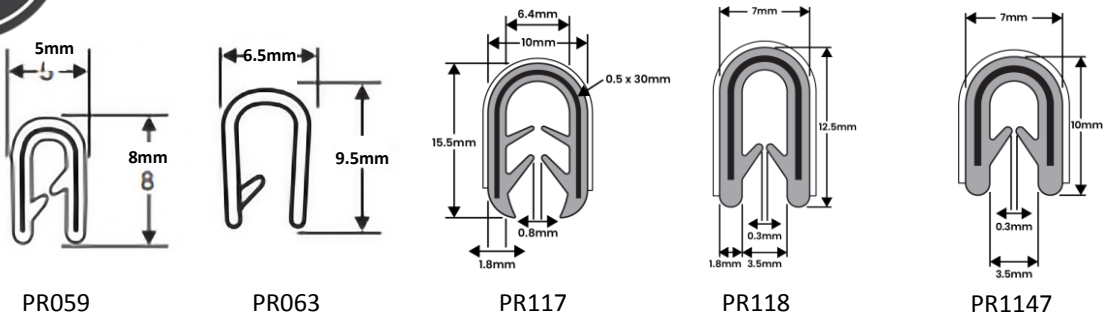

PINCH WELD DOOR SEAL

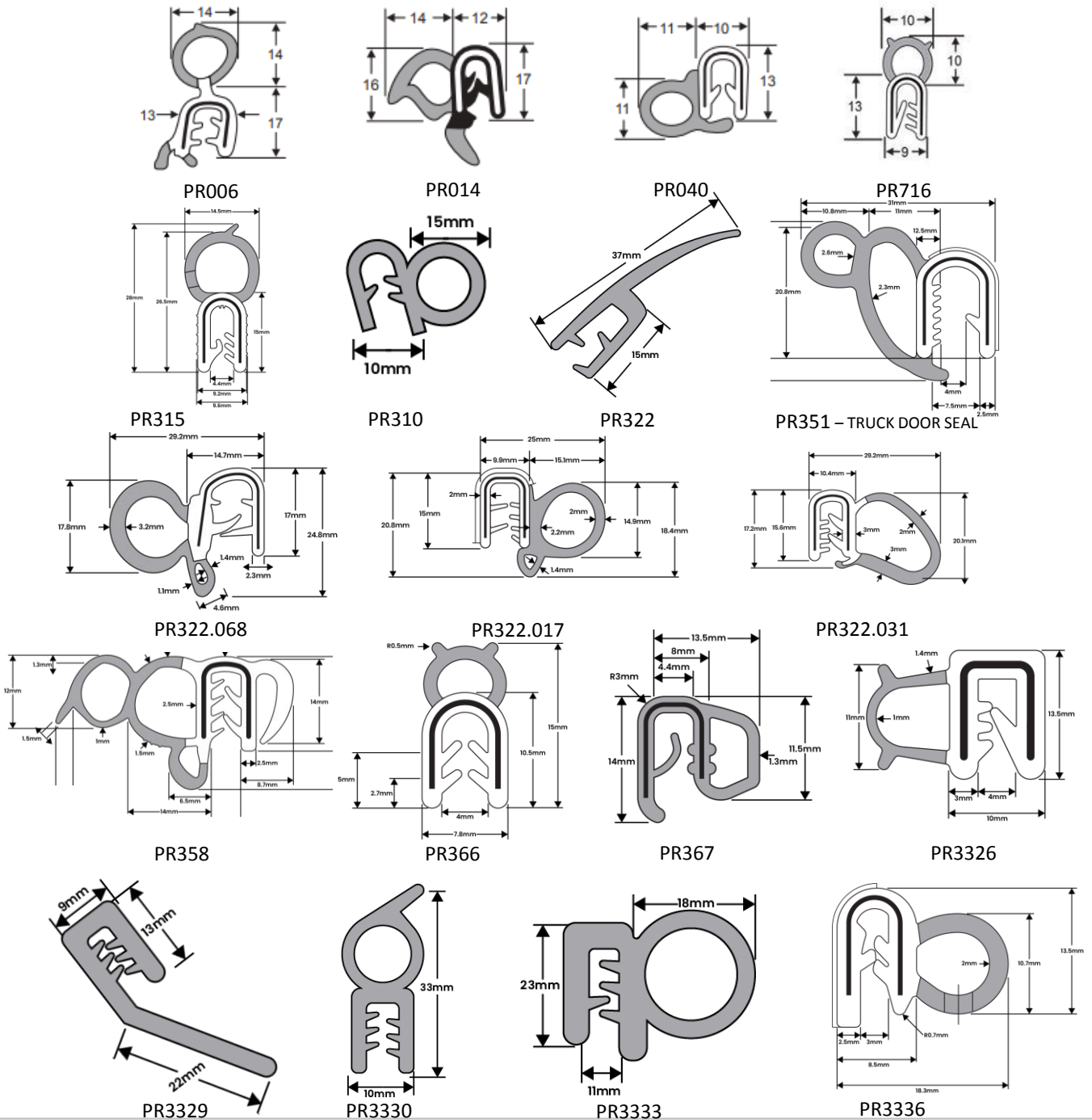



DOOR SEAL - J SECTION

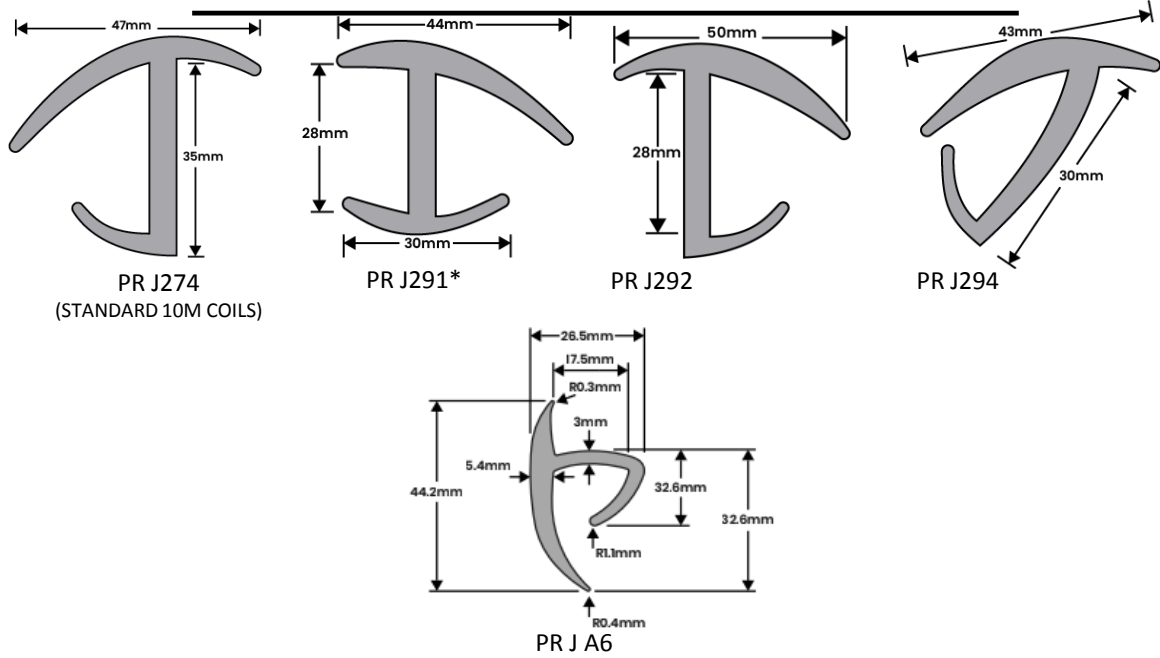

DOOR SEAL - H SECTION

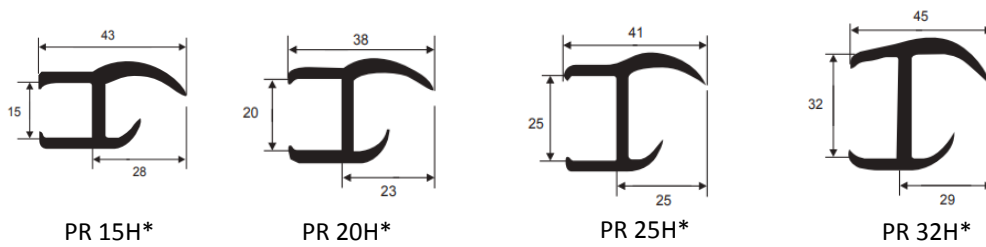

*non stock item minimum quantities apply

e SECTION

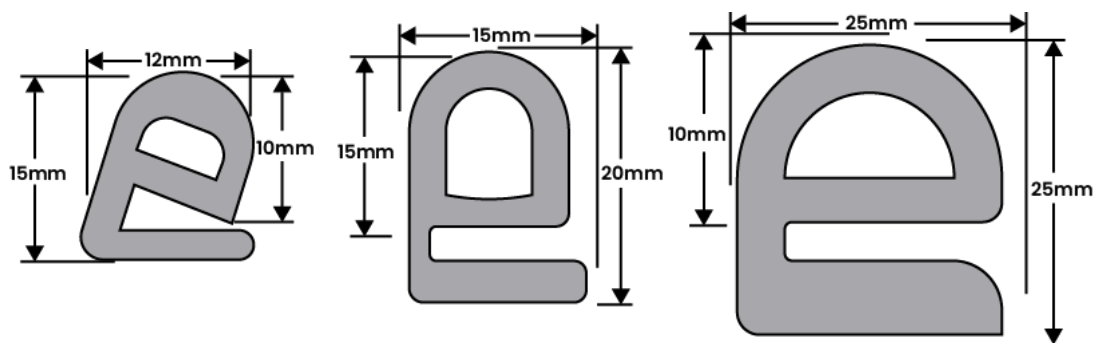

PR316 Small E Seal

PR317 Medium E Seal

PR318 Large E Seal

NOTE: SOME E RUBBERS ARE MANUFACTURED IN AN EPDM SPONGE



UNIVERSAL & VEHICLE SPECIFIC EXTRUSIONS

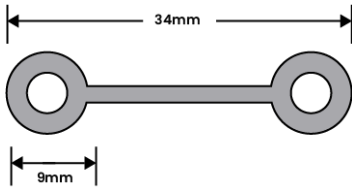

PR133 Chasis To Pan

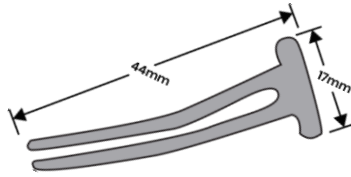

PR154 VW BEETLE ENGINE COMPARTMENT SEAL - EARLY MODEL

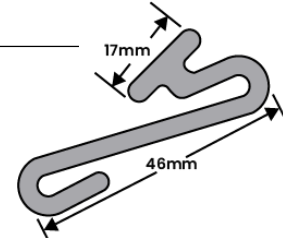

PR155 VW BEETLE ENGINE COMPARTMENT SEAL - LATER MODEL

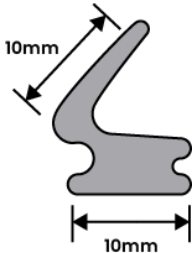

PR157w Ford Anglia Front 1/4 Vent Pillar



PR177 Edge Trim

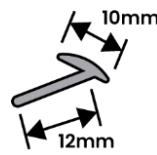

PR178 Large Handle & Badge

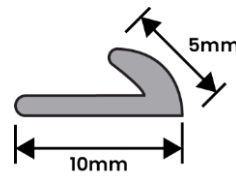

PR197

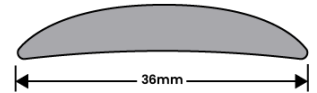

PR1127

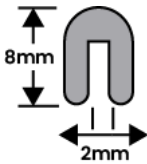

PR1129 Small Edge Trim

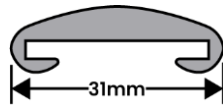

PR1130 Capping Rubber

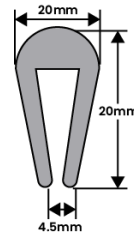

PR1139 Edge Trim

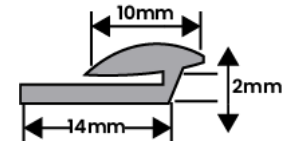

PR1178 Large Edge Trim

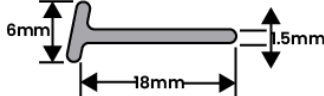

PR1272

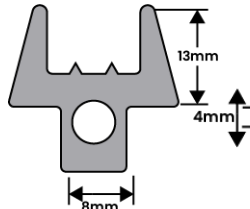

PR1283 1/4 Vent Seal

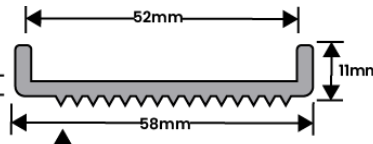

PR1285 Glass Rock Rubber

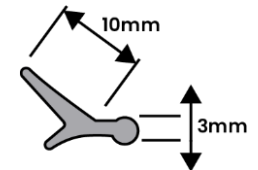

PR329 Beetle Engine Lid Seal

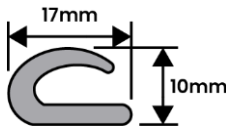

PR330 Uni C Seal



PR332 Uni Door Seal

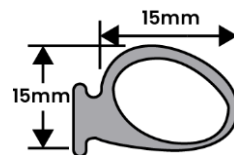

PR334 Jaguar XJ6 Door Seal



PR335 Morris Minor Door Seal

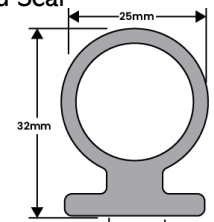

PR GD 3344

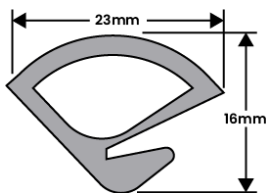

PR337 Mini Boot Seal

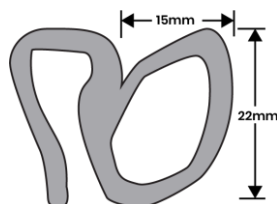

PR350 F250 Door Seal



PR365

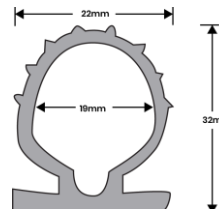

PR378

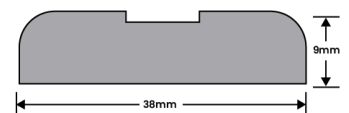

PR GW129 - SIDE BEADING

UNIVERSAL SPONGE EXTRUSIONS

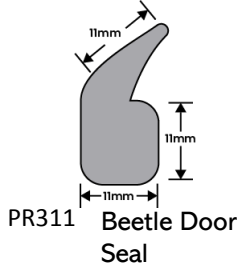

PR311 Beetle Door Seal

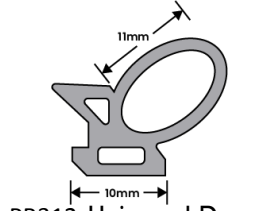

PR312 Universal Door Seal

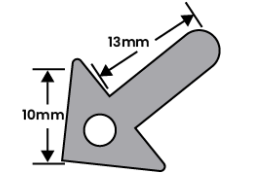

PR313 Nissan Door Seal

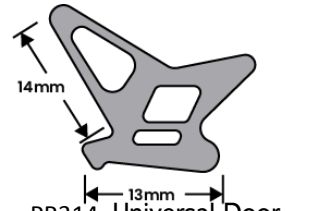

PR314 Universal Door Seal

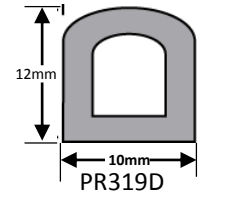

PR319D

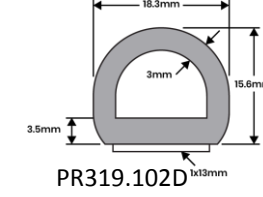

PR319.102D

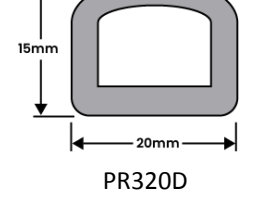

PR320D

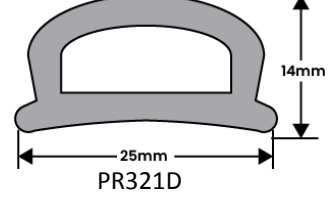

PR321D

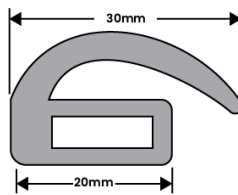

PR324 Landrover Door Seal

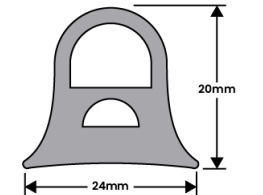

PR325D

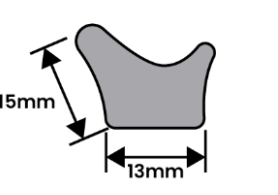

PR331 Uni Fish Tail

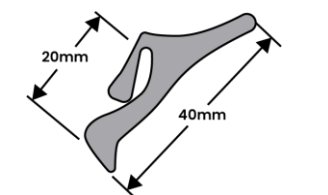

PR343 Canopy Seal

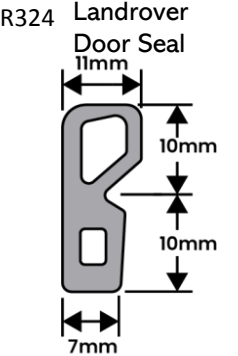

PR353 VW Golf 1 Door Seal

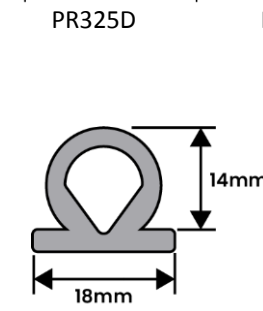

PR361D

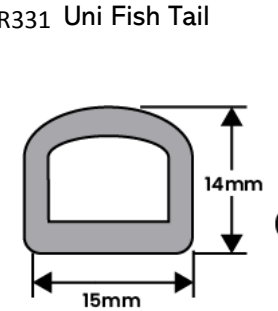

PR3310D

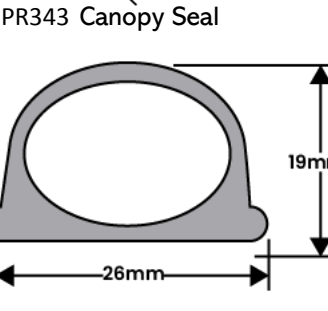

PR3305D

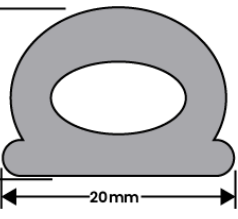

PR3343D

Universal Automotive & Industry Rubber Extrusions

Trying to understand where rubber extrusions might be used in the Australian manufacturing and production industry may seem like a confusing task. But the team at PAR Australia are fulfilling this role for our clients every day. We source clients looking for a holistic supplier of rubber extrusions who need an industry expert to provide advice on their process and identify the right products for their applications.



UNIVERSAL FENDER WELT

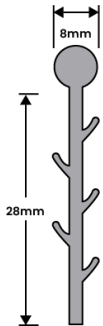

PR110 Fender Welt

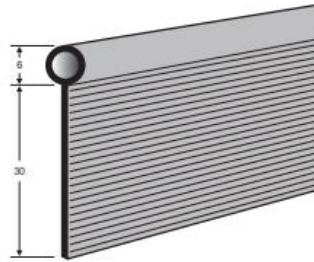

PR FW17365 PVC*

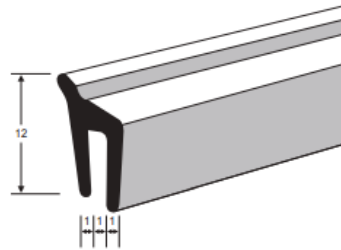

PR FW77-976 PVC

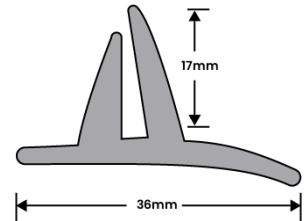

PR156 - MERCEDES V
SERIES FENDER WELT

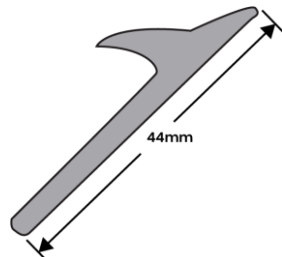

PR165 Morris Mirror
Traveller

WHEEL ARCH FLARES

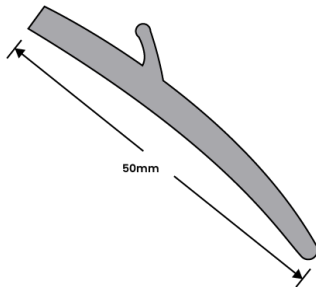

PR WF173

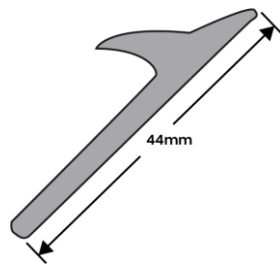

PR165



PR WF75*

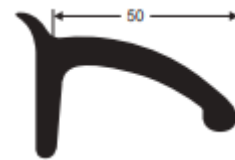

PR WF50*

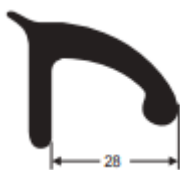

PR WF30*

*non stock item minimum quantities apply

WEATHER STRIP

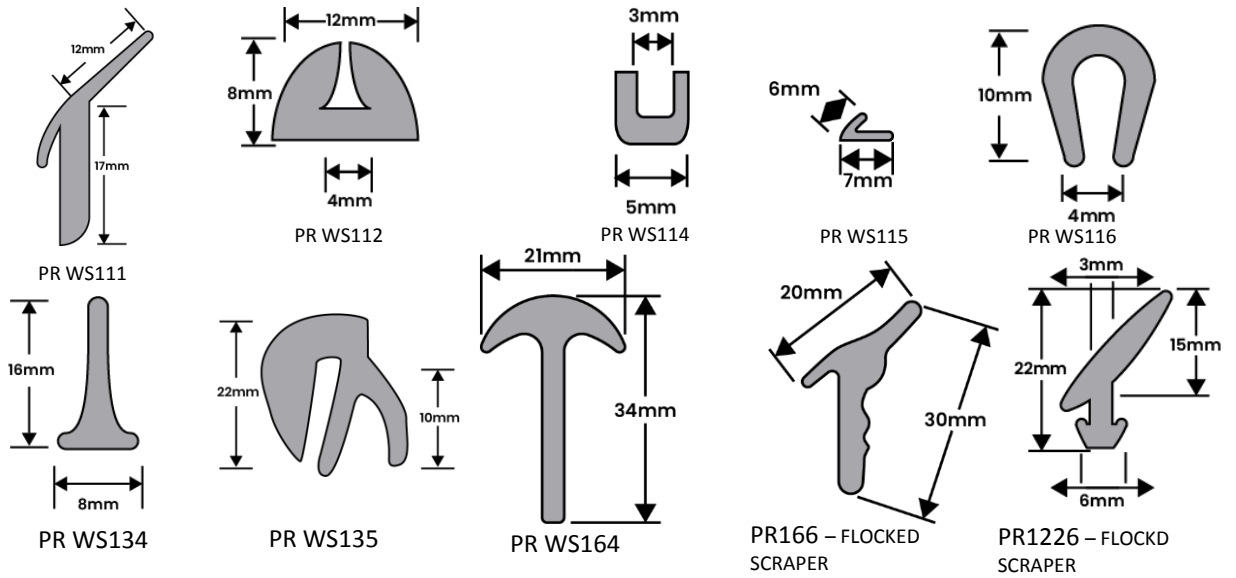

WEATHER STRIP - EPDM SPONGE

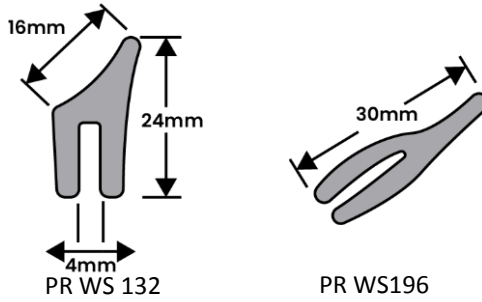

AUTOMOTIVE GLAZING RUBBER

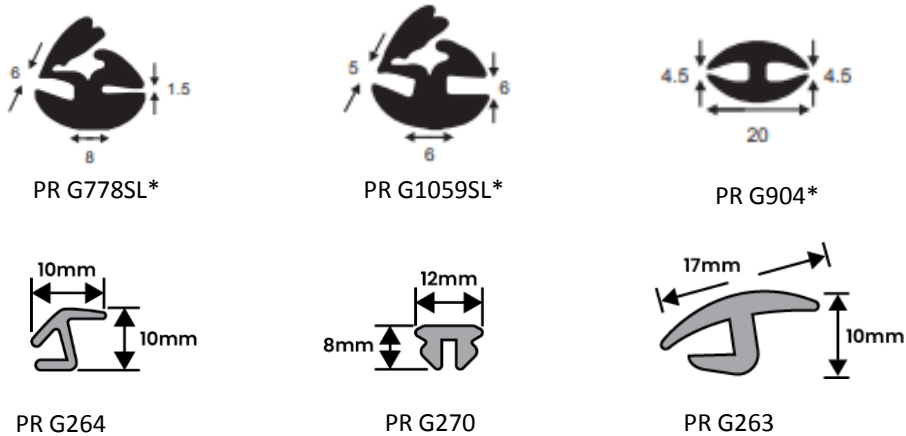



AUTOMOTIVE GLAZING RUBBER

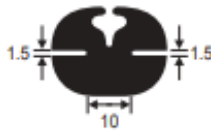

PR G2



PR G3



PR G4



PR G5



PR G6



PR G8



PR G10



PR G416



PR G503



PR G504

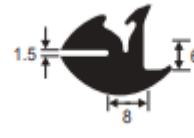

PR G778



PR G1059



PR G1294



PR G1300



PR G2



PR LOCK213 –
UNIVERSAL LOCKING STRIP

*non stock item minimum quantities apply

THE FOLLOWING GLAZING RUBBERS CAN BE SUPPLIED WITH (B) OR WITHOUT AN INTERNAL BUTYL STRIP

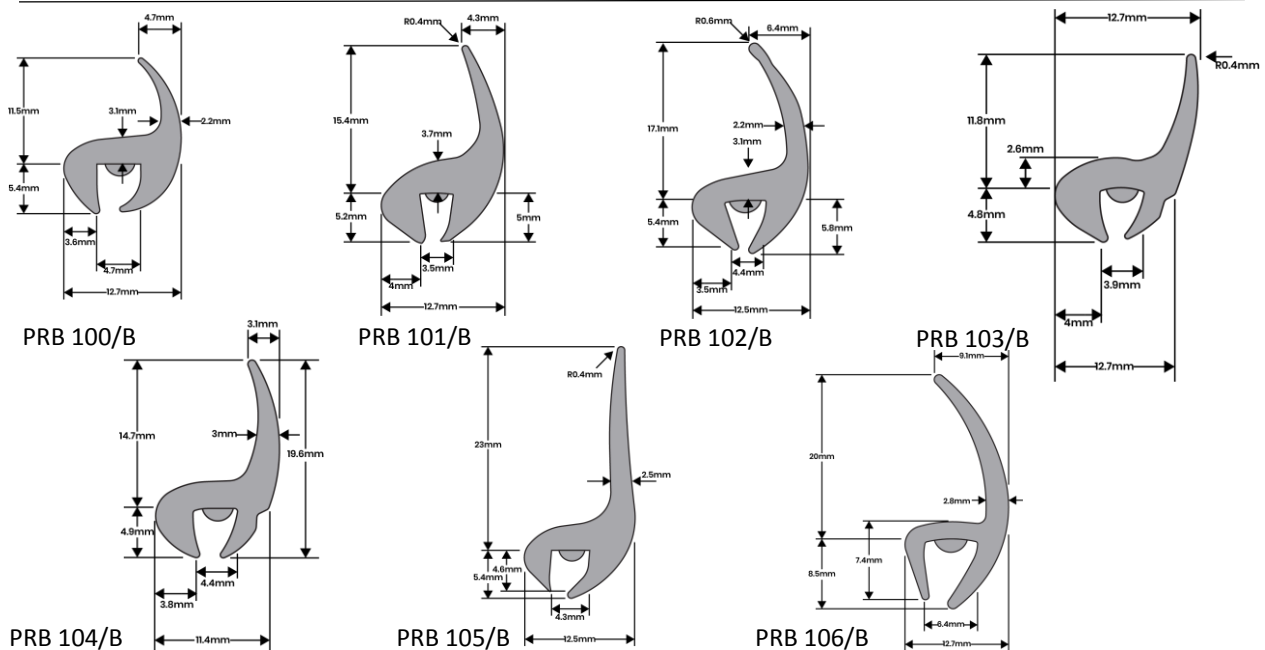



UNIVERSAL WINDSCREEN MOULDS – SELF ADHESIVE

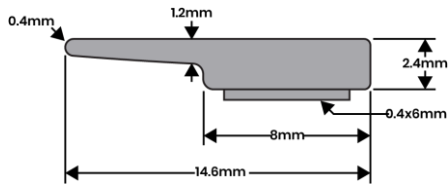

PRBA1

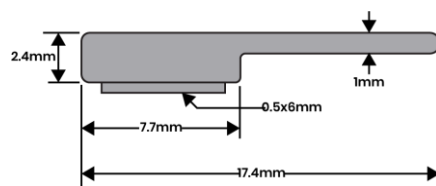

PRBA2

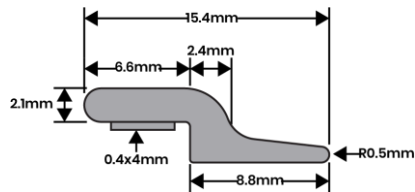

PRBA3

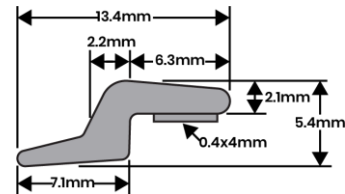

PRBA4

BAILEY CHANNEL

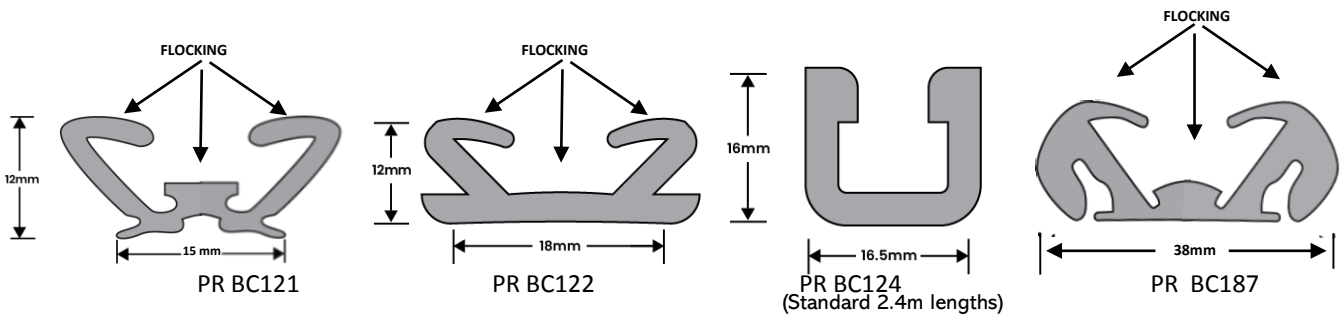

BUILDING PROFILES – GLAZING WEDGES

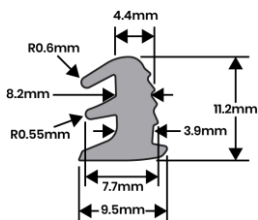

PR800

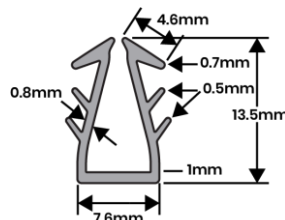

PR806

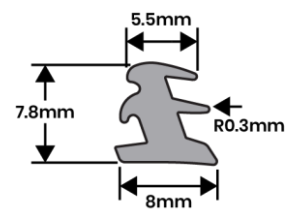

PR811

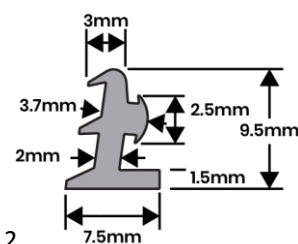

PR812

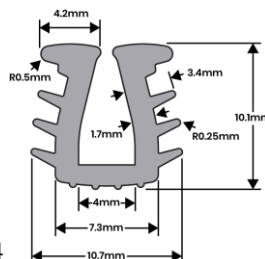

PR814

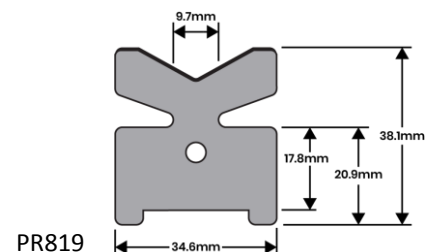

PR819



SELF ADHESIVE SPONGE EXTRUSIONS

PAR can offer a range of our extrusions in varying materials with a self-adhesive backing. This makes our products highly versatile and broadens depth of application.

(Minimum Run Required)



PRD1989T
20 X 20 SELF
SPONGE D SECTION



PR135DT
19 X 14.3
SPONGE D SECTION



PR109DT
16 X 9.5
SPONGE D SECTION



PR119DT
19 X 9.5
SPONGE D SECTION



PR125DT
19 X 12.7
SPONGE D SECTION



PR925ST
32 X 21 X 4 WALL



PR 319T
18 X 18 SELF
SPONGE D SECTION



PR 54T
16 X 12
SPONGE D SECTION

STANDARD 30 METRE COILS

P SECTION

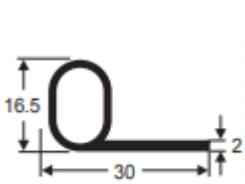

PR P104*



PR P107*

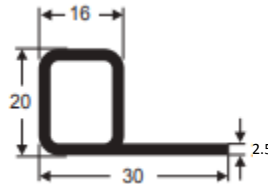

PR P109*

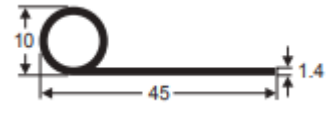

PR P111*



PR P409

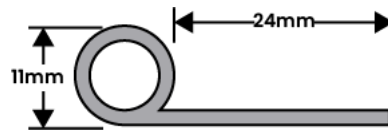

PR1202

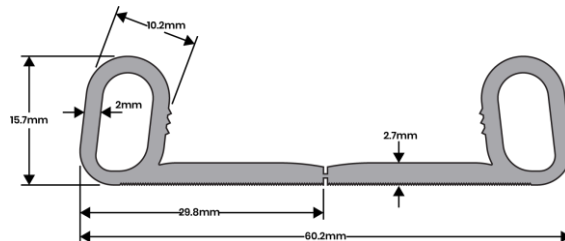

PRA4

*non stock item minimum quantities apply

U CHANNEL

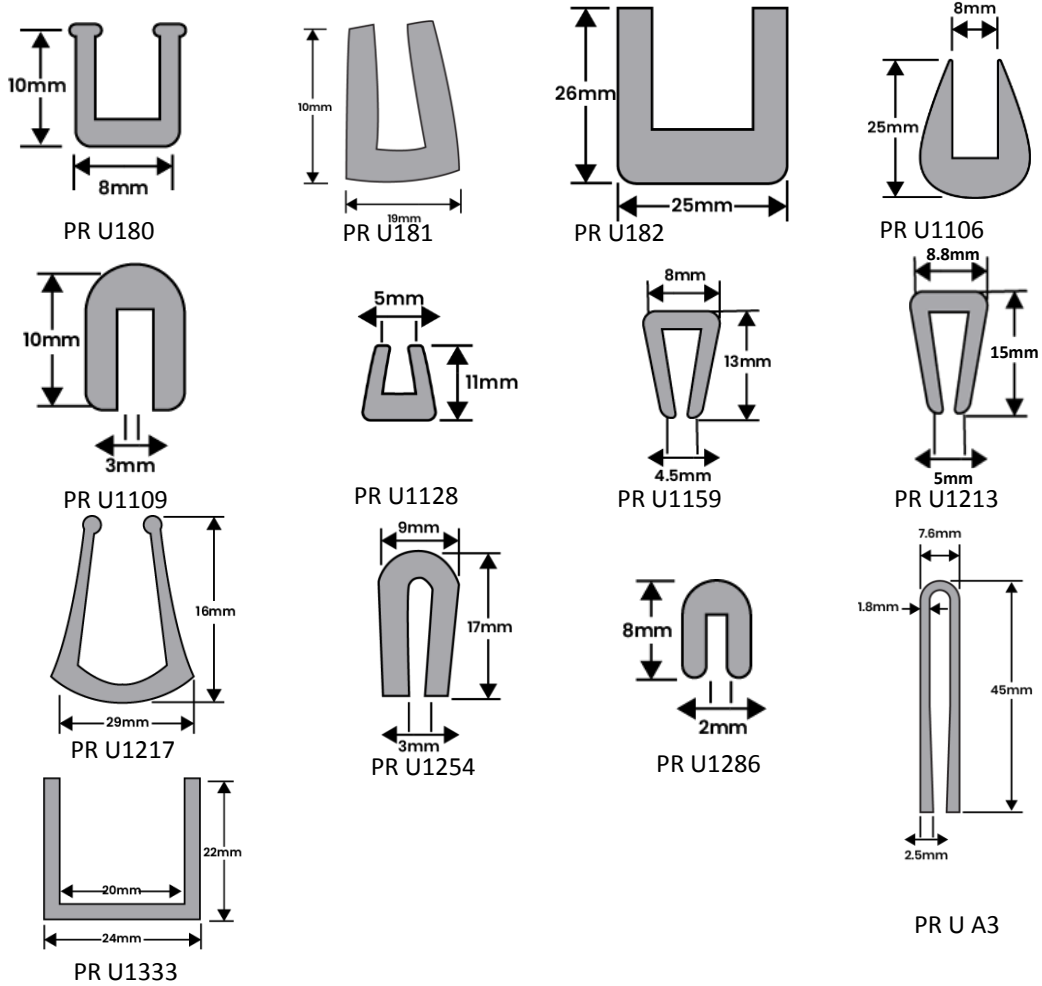

CAPPING RUBBER

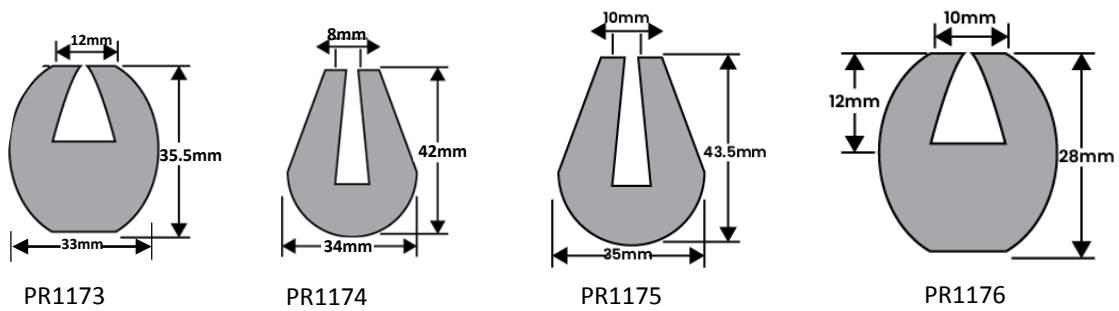

L SECTION

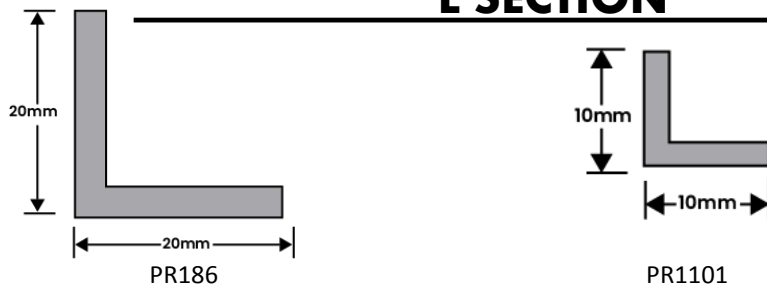



BRACKET STRAPS

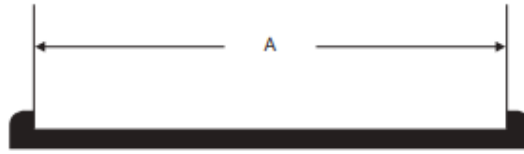

PART #	A (mm)	MATERIAL
BS 25 EPDM*	25	EPDM
BS 25NBR*	25	NITRILE
BS 50 EPDM*	50	EPDM
BS 50NBR	50	NITRILE
BS 52NBR*	52	NITRILE
BS 54NBR	54	NITRILE
BS 75 EPDM*	75	EPDM
BS 75NBR	75	NITRILE
BS 78NBR	78	NITRILE

PAR Australia can supply a range of tank and bracket straps in either EPDM or NITRILE (NBR) rubbers. Some sizes are non-stock and manufactured to order. Please enquire with our team for your requirements

TANK STRAPS

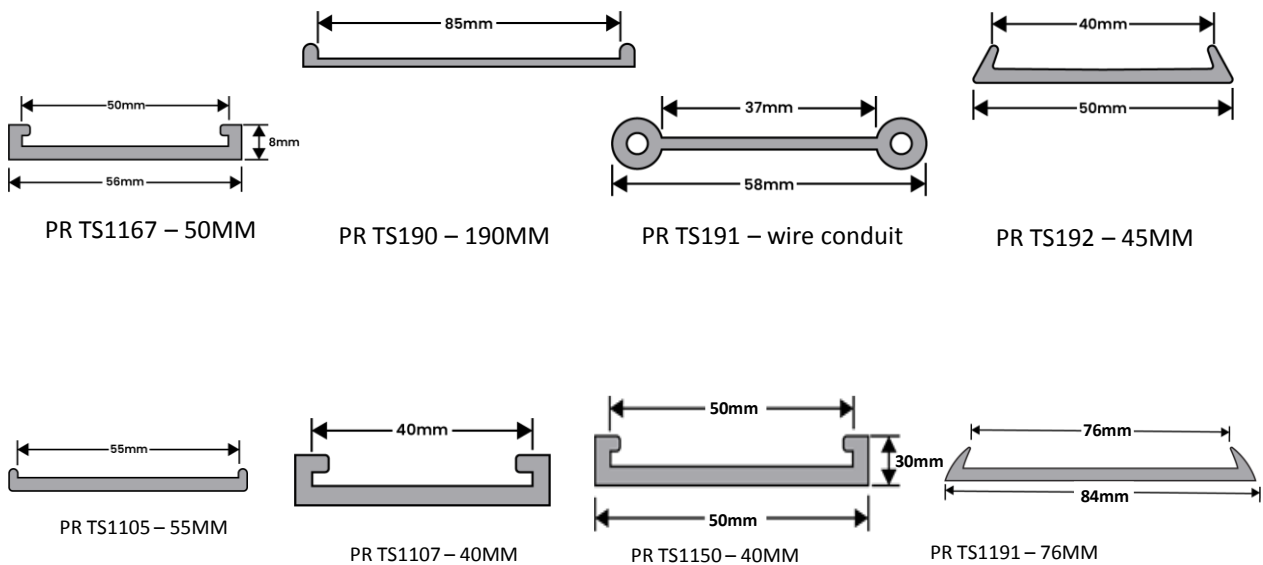



TANK STRAPS



PR TS1209 –
110MM

PR TS20 NBR *
- PR TS 20EPDM*

PR TS 25EPDM*
- PR TS 25NBR*

PR TS 52EPDM*
- PR TS 52NBR*



PR TS 63EPDM*
- PR TS 63NBR*



PR TS 75EPDM*
- PR TS 75NBR*

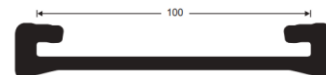

PR TS 100EPDM*
- PR TS 100NBR*

*non stock item minimum quantities apply

EPDM SPONGE EXTRUSIONS

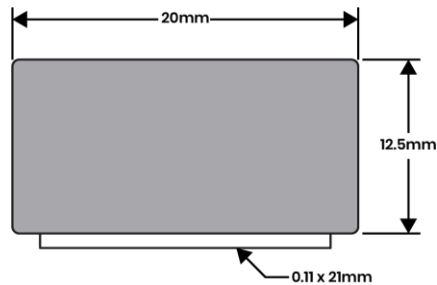

PR260.019
RECTANGULAR STRIP 25MM X 15MM

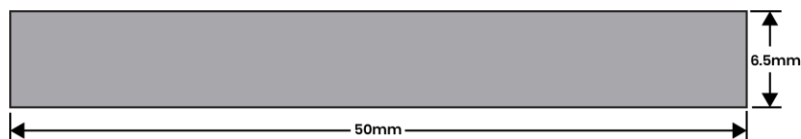

PR260.108
RECTANGULAR STRIP 50MM X 7MM

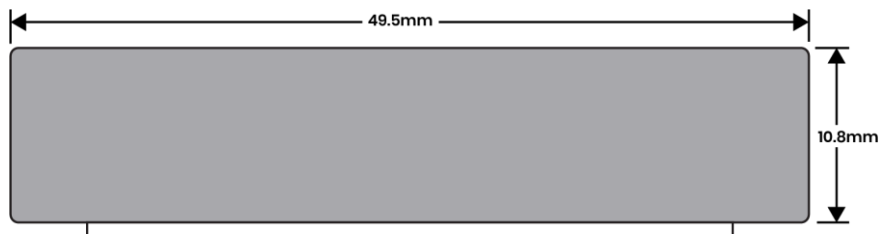

PR260.132
RECTANGULAR STRIP 50MM X 10MM

THE ABOVE ARE STANDARD SIZES ONLY. WE CAN EXTRUDE EPDM SPONGE FLAT IN ALMOST ANY SIZE. TOOLING COST MAY APPLY. MIN RUNS APPLY.



SOLID EPDM BLOCKS

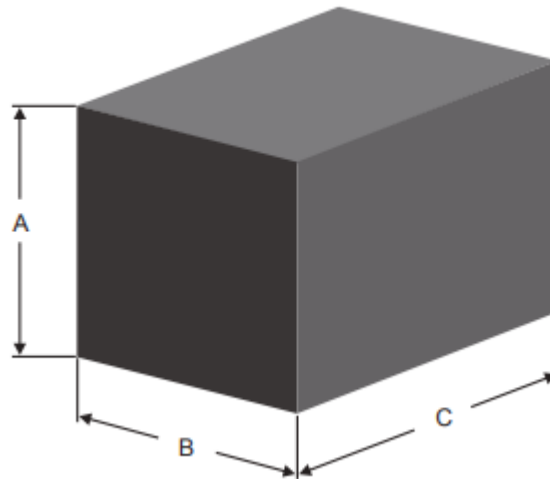

A (mm)	B (mm)	C (mm)
50	50	250
50	50	500
75	75	250
75	75	500
100	75	100
100	75	150
100	75	250
100	75	500
100	100	100
100	100	150
100	100	250
100	100	500

*non stock item minimum quantities apply



SOLID EPDM RUBBER STRIP - STANDARD STOCK ITEMS

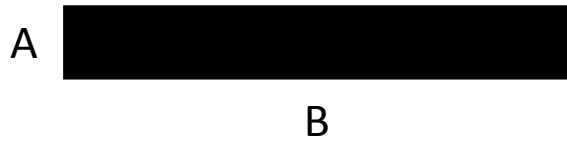

PART #	A (mm)	B (mm)
PR397	3	10
PR194	5	48
PRA1	3	55
PRA2	3	80

SOLID EPDM RUBBER STRIP - MANUFACTURED AND SUPPLIED TO ORDER

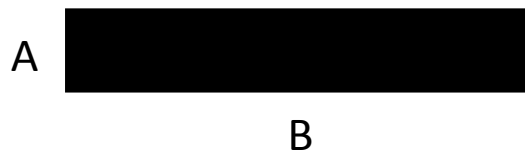

A (mm)	B (mm)
5	5
6	6
10	10
15	10
20	12
20	20
22	15
25	10
30	10
30	15
38	4.5
40	12
50	10
60	12
75	10
80	6
100	12

THE ABOVE ARE STANDARD SIZES ONLY. WE CAN EXTRUDE EPDM STRIP IN ALMOST ANY SIZE. TOOLING COST MAY APPLY. MIN RUNS APPLY.

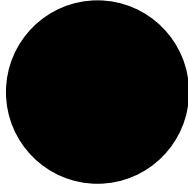

EPDM SPONGE CORD

A  (DIAMETER)

PART #	A (MM)
PR C 381E	4
PR C 382E	6
PR C 383E	8
PR C 384E	10
PR C 385E	12
PR C 16E	16
PR C 19E	19
PR C 22E	22
PR C 25E	25

THE ABOVE ARE STANDARD SIZES ONLY. WE CAN EXTRUDE CORDS IN ALMOST ANY SIZE IN THE FOLLOWING MATERIALS. TOOLING COST MAY APPLY. MIN RUNS APPLY.

- EPDM SOLID/SPONGE
- NEOPRENE SOLID/SPONGE
- SILICONE SOLID
- PURE GUM



GUNWHALE RUBBER

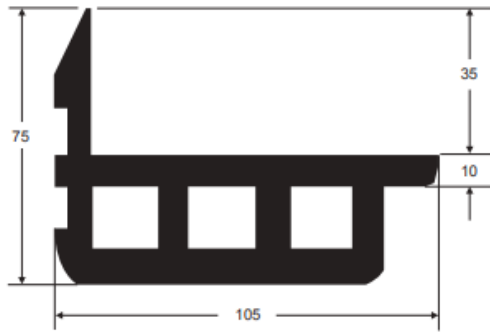

PR DR1153

PONTOON RUBBER
AVAILABLE IN CUSTOM LENGTHS

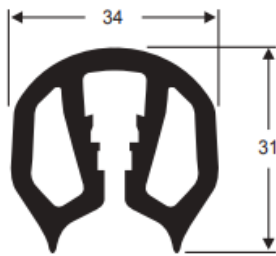

PR GUN2358
30 METRE COIL

PLASTIC GUNNEL AVAILABLE IN
BLACK OR WHITE

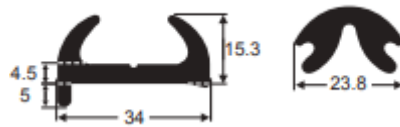

PR GUN2303

PR GUN2304

30 METRE COIL

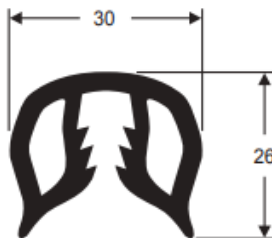

PR GUNN 2376
30 METRE COIL



MANUFACTURED & SUPPLIED TO ORDER



CABLE PROTECTORS

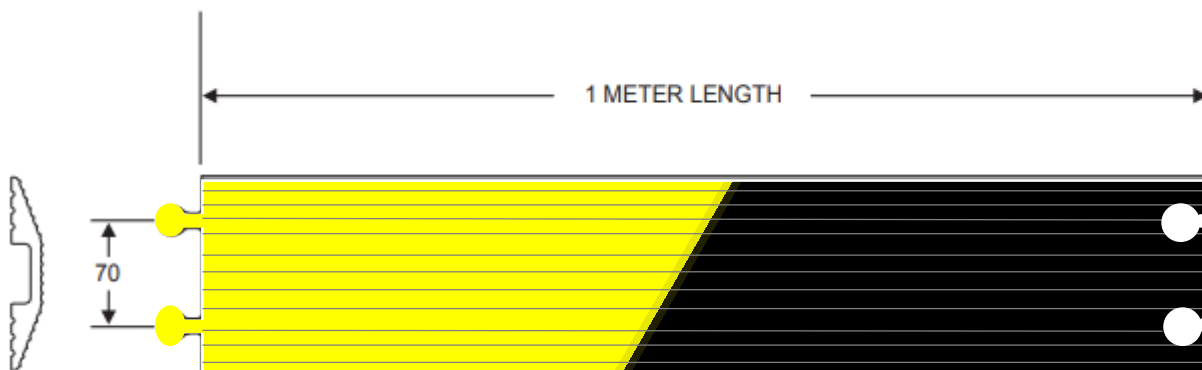
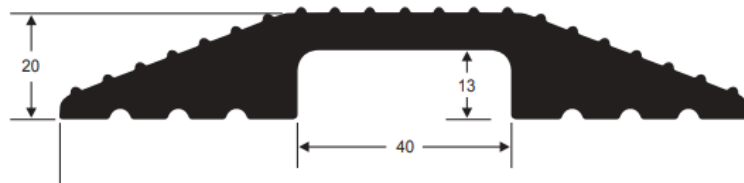
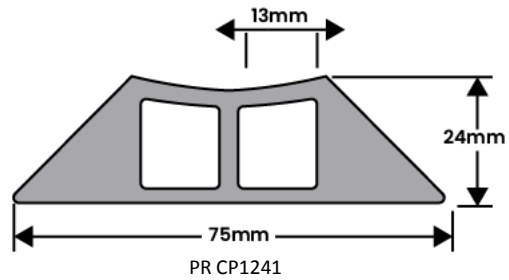

PR CP13020

AVAILABLE IN BLACK OR YELLOW
AVAILABLE IN CLIP TOGETHER 1 METRE LENGTHS



WIRING GROMMETS

BAGS OF 100 UNITS

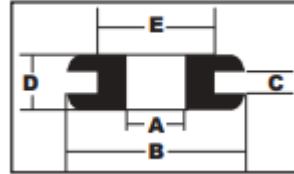

PART No.	A	B	C	D	E
WG 157	5.50	11.00	0.80	4.00	8.00
WG 158	5.50	11.00	1.60	4.80	8.00
WG 159	5.50	11.00	2.40	5.50	8.00
WG 178	3.20	11.00	0.80	6.40	8.70
WG 163	3.20	12.70	1.60	6.40	9.50
WG 164	6.40	14.30	0.80	6.40	9.50
WG 167	8.00	19.80	4.00	8.00	11.00
WG 168	9.50	17.50	3.20	6.40	11.00
WG 171	8.00	15.00	3.20	8.00	11.90
WG 185	6.70	16.00	1.60	8.00	11.90
WG 176	8.00	17.00	2.80	9.00	12.10
WG 161	9.50	16.00	1.60	6.40	12.10
WG 160	7.20	15.00	1.60	8.00	12.70
WG 183	9.50	17.50	1.20	7.20	14.30
WG 165	11.70	20.00	3.00	9.30	15.80
WG 182	9.50	20.60	1.60	7.20	16.70
WG 170	11.00	25.40	1.60	8.00	19.00
WG 180	12.70	28.60	1.60	6.40	22.03
WG 174	16.00	29.30	2.40	9.50	22.30
WG 184	19.00	35.00	1.60	8.00	24.00
WG 173	16.00	29.40	2.40	7.20	25.40
WG 1127A	19.00	33.30	1.60	8.00	27.00
WG 186	29.00	46.00	1.60	12.70	34.10

SIZES GIVEN ARE NOMINAL MEASUREMENTS



BLANKING GROMMETS

BAGS OF 100 UNITS

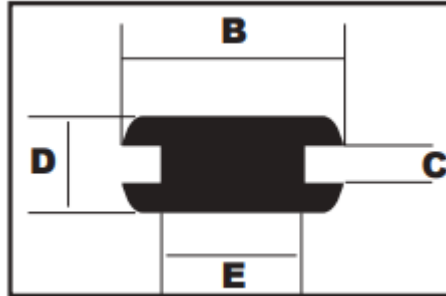

PART No	B	C	D	E
BG 2262	9.50	1.60	4.80	6.40
BG 2159	11.00	1.60	4.80	8.00
BG 2114	12.70	1.60	4.80	9.50
BG 2114	17.50	1.60	6.40	12.70
BG 2115	20.60	1.60	6.40	16.00
BG 2161	25.40	1.60	6.40	19.00
BG 2160	28.60	1.60	6.40	22.30
BG 2240	31.80	1.60	8.00	25.40
BG 2194	35.00	1.60	8.00	28.60
BG 2129	38.10	1.60	8.00	31.80
BG 2273	44.50	1.60	8.00	38.10

SIZES GIVEN ARE NOMINAL MEASUREMENTS



PROAUTO RUBBER AUSTRALIA

CYANOACRYLATE ADHESIVE SUPER GLUE



EPDM Cyanoacrylate 606 20GSM Super Glue

This super glue offers an exceptionally fast cure speed which is perfect for bonding difficult substrates and acidic surfaces. It works well with wood, PVC, substrates that contain plasticizers, EPDM, etc. This Cyanoacrylate super glue is easy to use and bonds almost anything.

AVAILABLE IN LARGER QUANTITIES



HOIST LIFT BLOCKS

PAR Australia have a range of replacement hoist lift blocks
For further information, Enquire within.



ANTI-VIBRATION MOUNTS



PAR manufacture a wide range of anti-vibration mounts.
Multiple sizes both male and female, for most applications.
Wholesale and trade prices. Enquire within.

Contact the team on:

(02) 6025 0194

sales@proautorubber.com.au

919 Metry St North Albury NSW 2640



MUD FLAPS

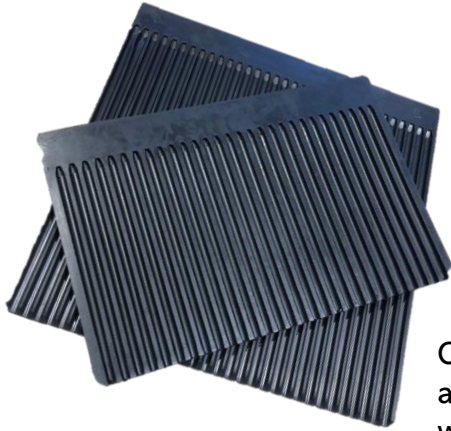

EPDM truck, trailer and service body mud flaps. Much stronger than PVC mudflaps and still flexible enough to move with the vehicle. Enquire within.

Custom mud flap weights available in mirror stainless steel w/ your custom laser cut logo .



WHEEL CHOCKS

PAR manufacture and supply heavy duty PVC and RUBBER wheel chocks. Perfect for your car, trailer or truck. For further information enquire within.

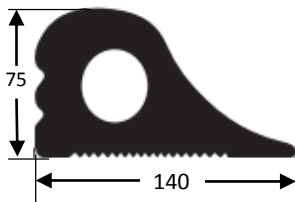

PR WC CAR1792



PR CHOCKY



PRLB08 LONG
PRLB06 SHORT

AVAILABLE FOR AUSTRALIA'S MOST POPULAR 4X4'S

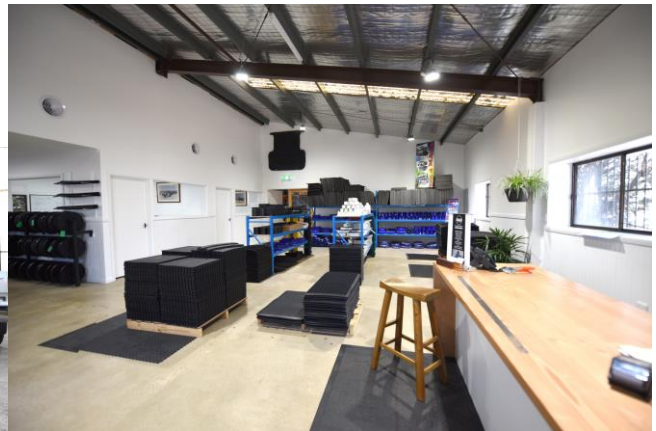

919 METRY ST NORTH ALBURY NSW

(02) 6025 0194

sales@proautorubber.com.au

www.proautorubber.com.au